



Here are some folds & puzzles using paper.

[banger](#)

[Rick Nordal's surprise fold](#)

[foil flower](#)

[paper pistol](#)

[sasaki's puzzle](#)

[sunglasses](#)

[Simple Models](#)



# Banger

works with other rectangles - the bigger the louder!

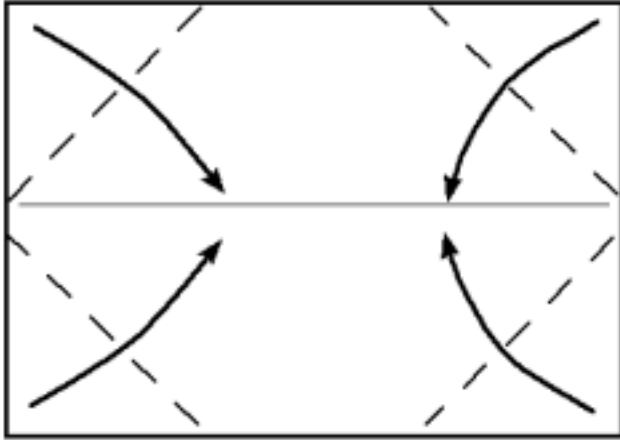

fold the corners to the centre crease

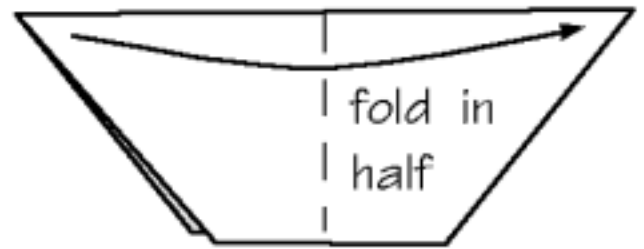
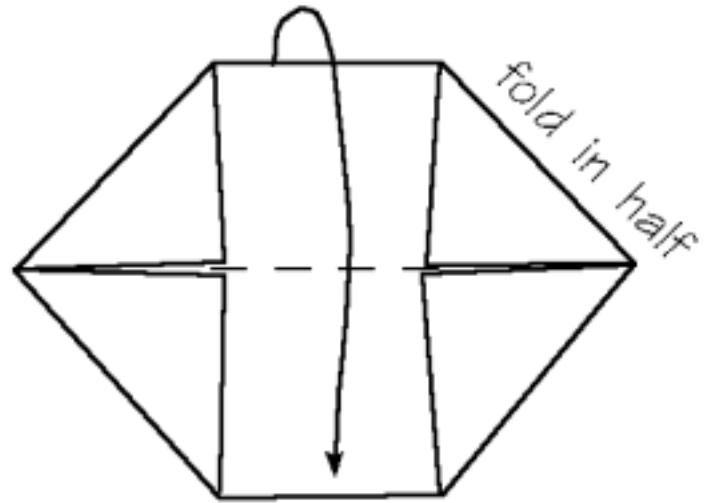

# BANG!

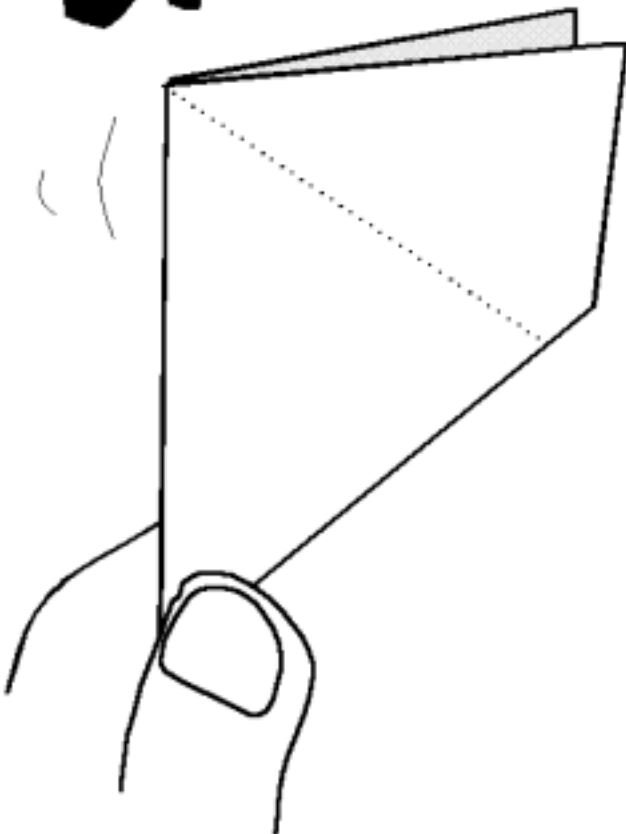

swing both flaps down

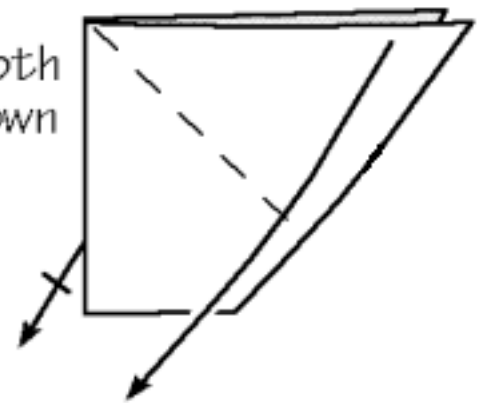

# Origami Surprise

print this page, cut out the picture below & follow the instructions!

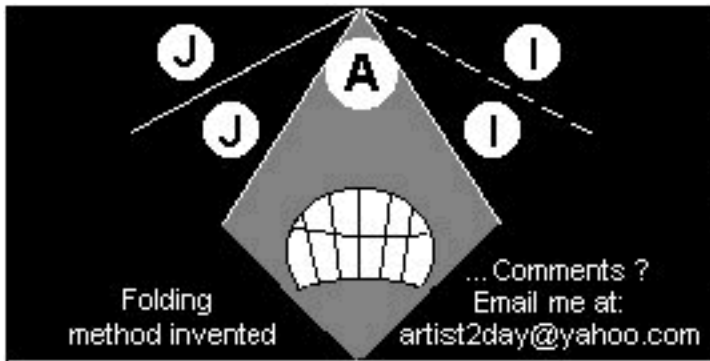

Folding method invented by Rick Nordal

... Comments? Email me at: artist2day@yahoo.com

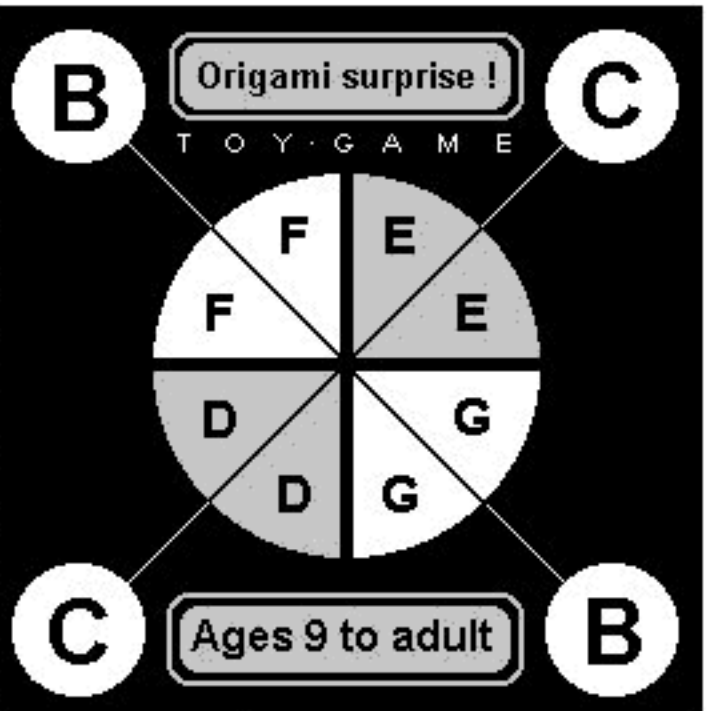

Origami surprise!

TOY GAME

Ages 9 to adult

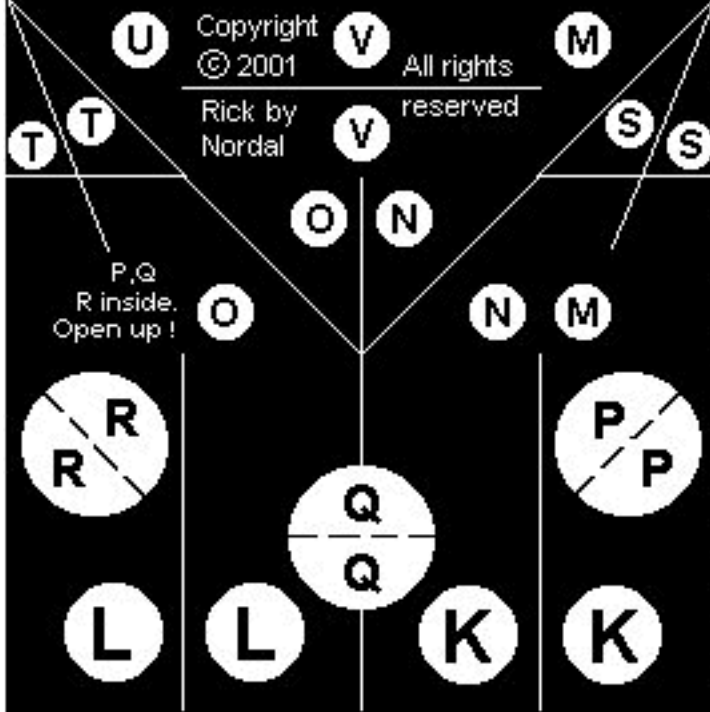

Copyright © 2001 Rick by Nordal

All rights reserved

P, Q R inside. Open up!

In just a few minutes fold this paper... into a amazing jumping toy!



In alphabetical order fold same two letters together so that they "kiss" each other. Letters "A, B, C," fold and then unfold. All other letters fold, but do not unfold.



To make your toy jump, push down on very back edge and slide your finger away from the toy. Can you jump this toy into a cup? Enjoy!



# Flower

works with ordinary foil - you don't have to start smoking!

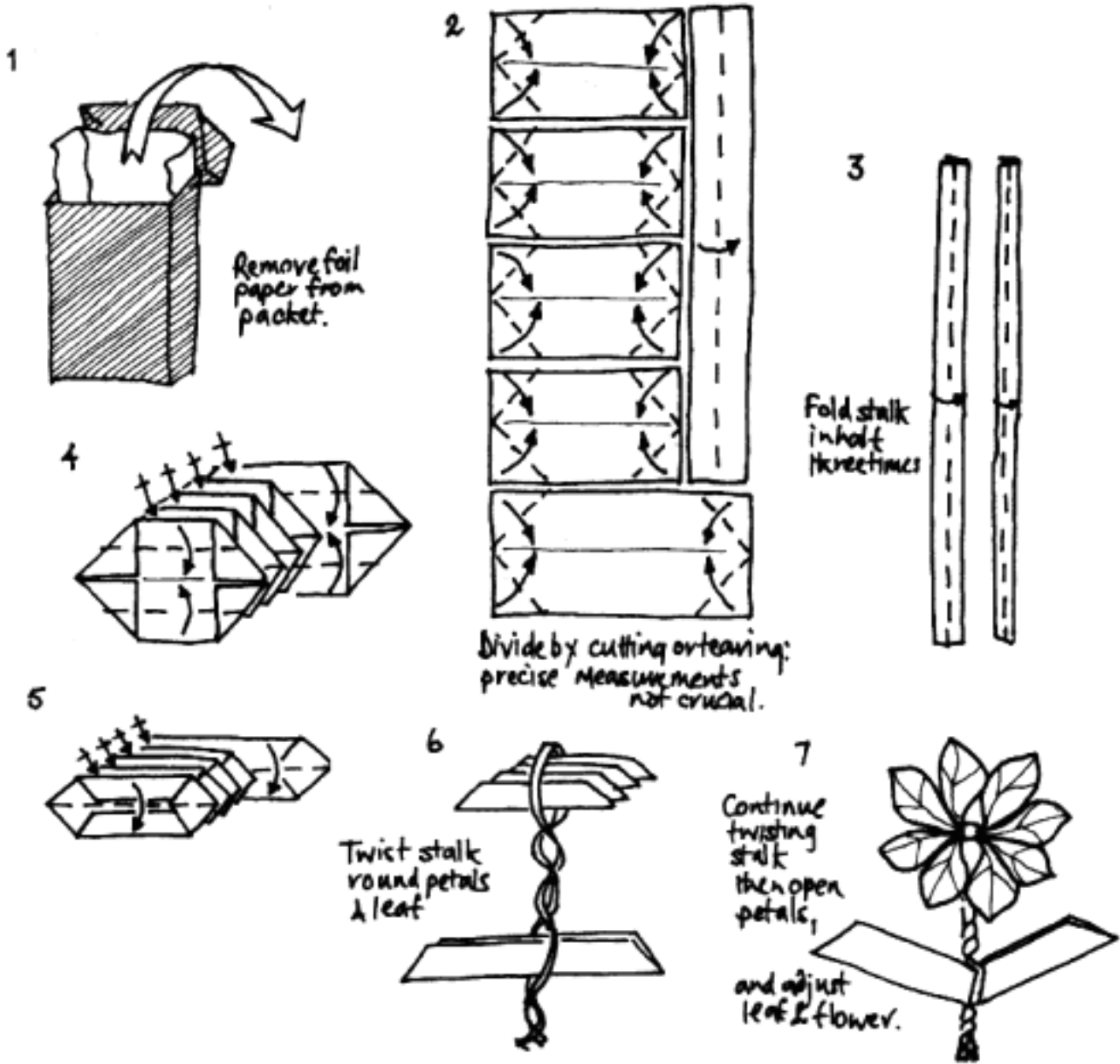

This design was folded by a barman in Cyprus!  
Diagrams D. Brill © BOS

# Origami Pistol

Pull the trigger, shout "BANG"!

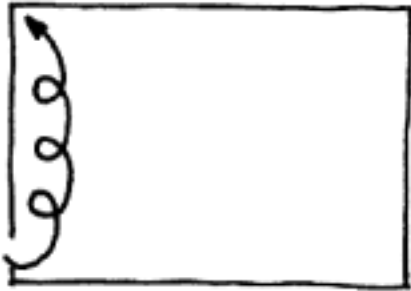

Roll tightly

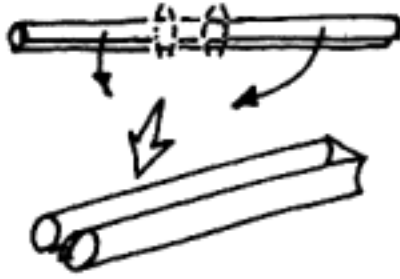

double tube but retain roundness of barrels

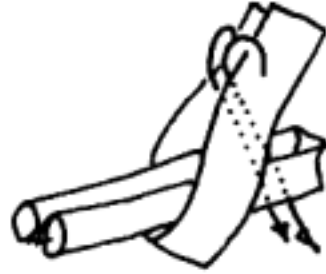

loop handle around and between barrels

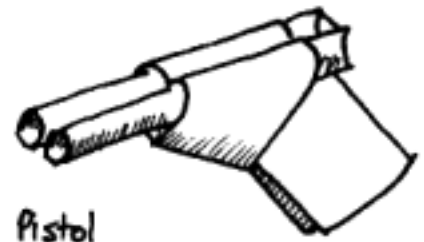
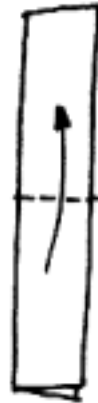
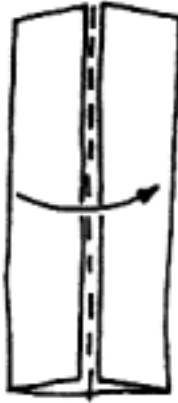
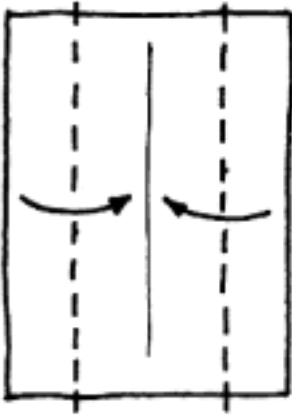

Pistol collected by Julien Correia

This "playground" design was discovered by 11 year old Julien Correia.  
Diagrams D. Brill © BOS



## Sasaki's Puzzles

Here are some folding puzzles to get your brain and fingers working!

The idea is to reproduce the colour/white pattern exactly, using as few folds as possible. The target number of folds is shown in brackets by each pattern. Don't forget there are no rules, so you can start using diagonals, fifths, thirds, quarters, anything you want! Several other combinations of the nine available squares are possible....

There are no prizes available, but it's a lot of fun!

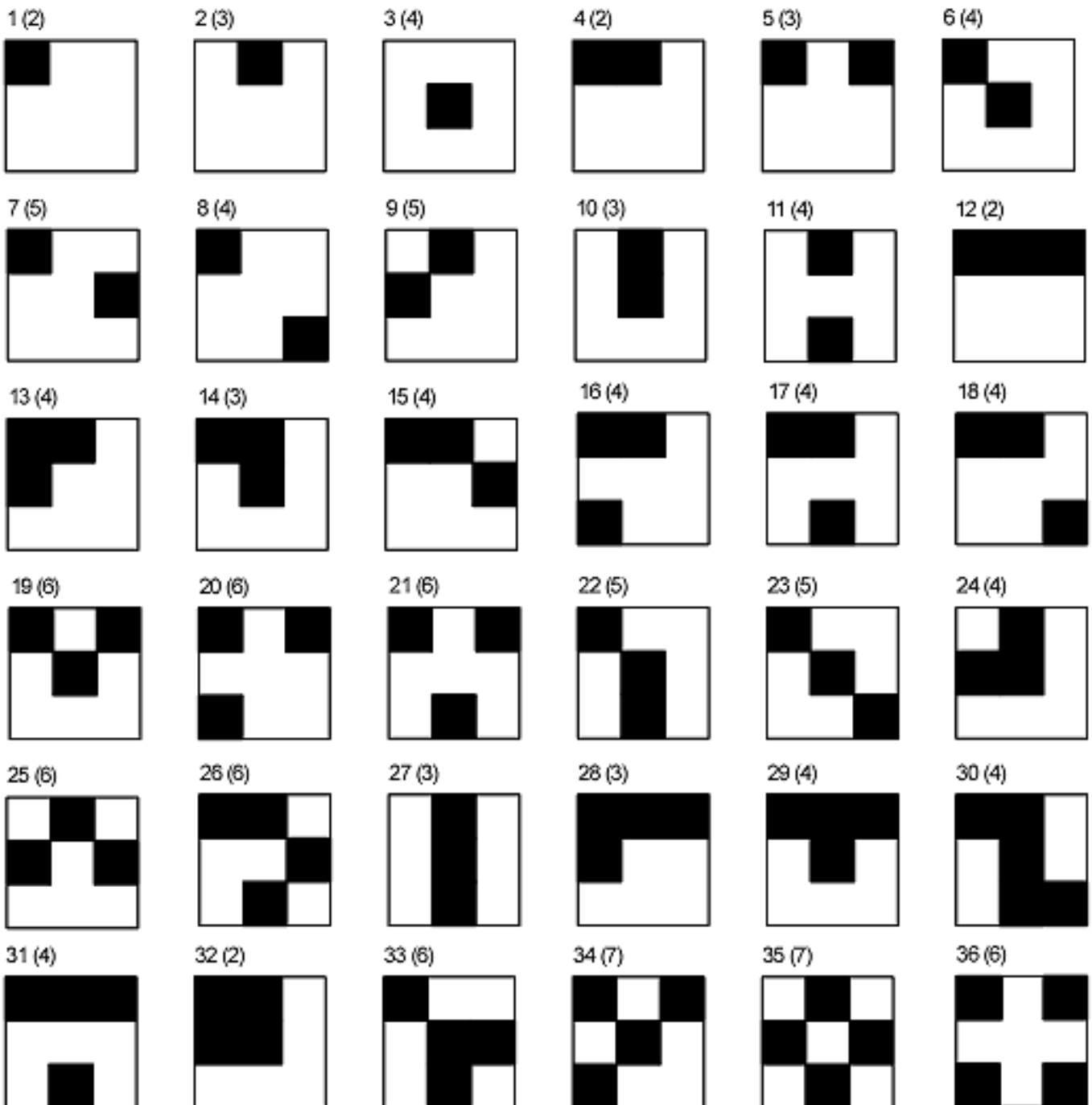

# Sunglasses

works with other rectangles - adjust starting size to suit head!

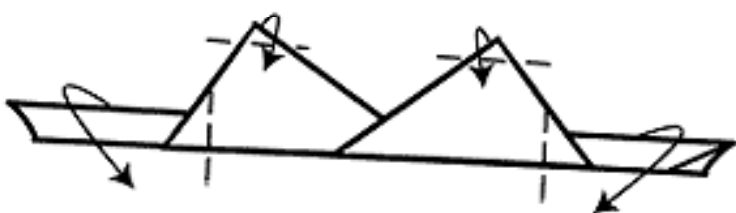
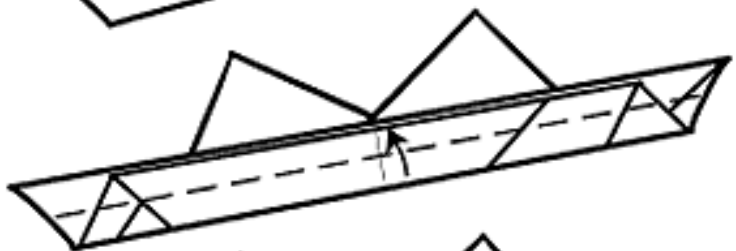
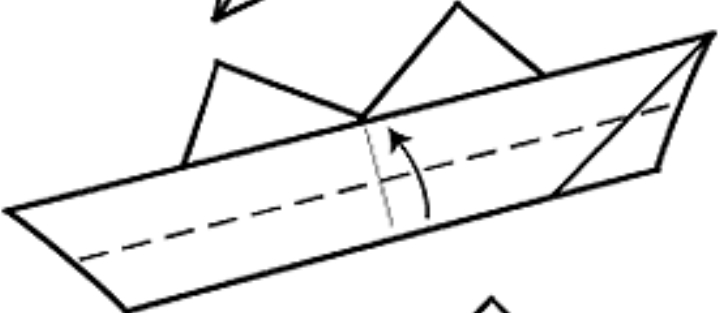
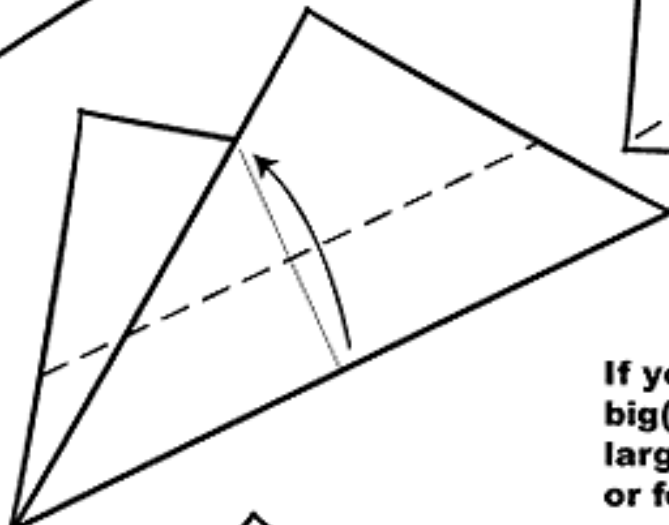
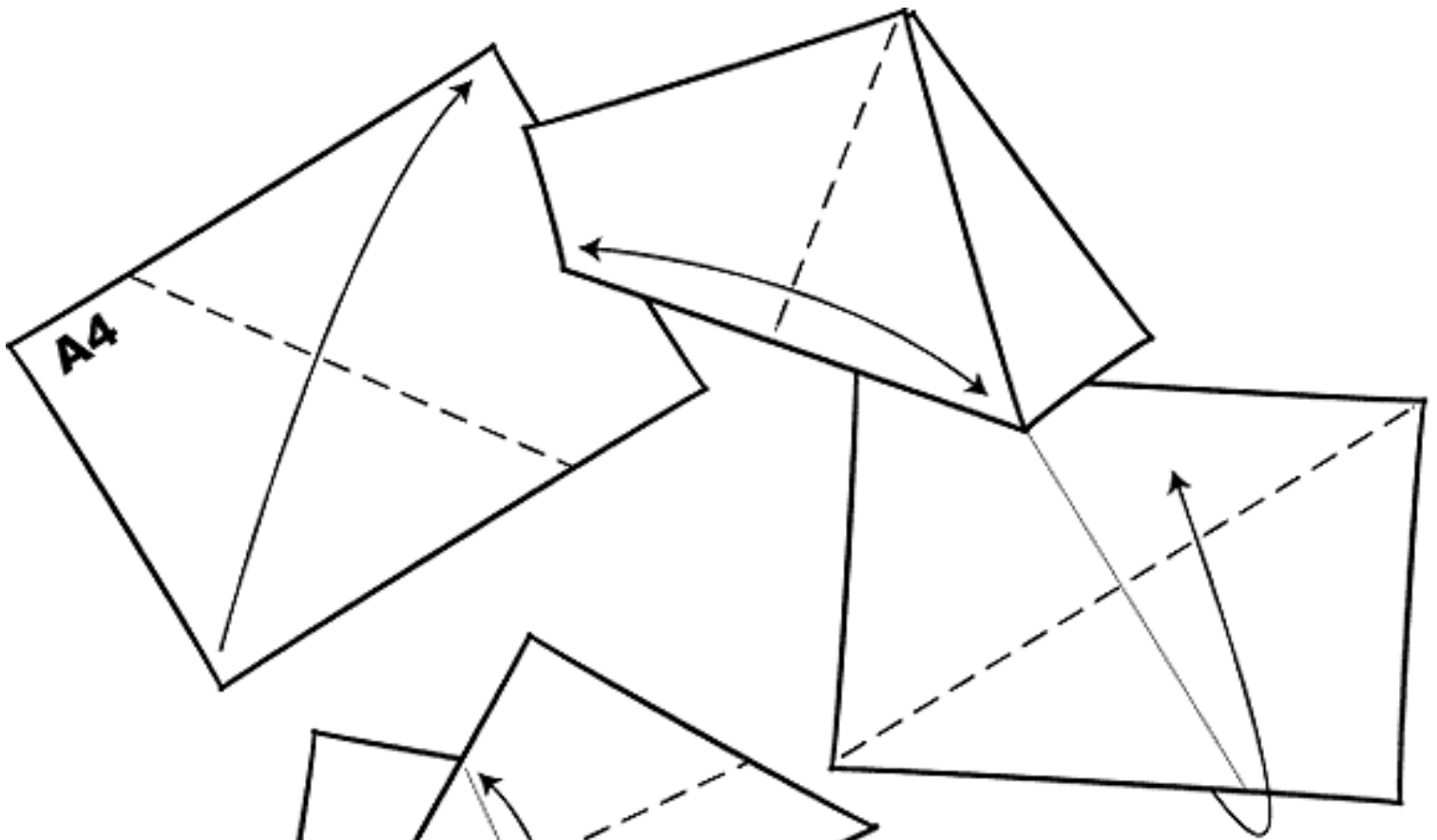

If your head is too big(!) either use a larger rectangle, or fold a square as shown - this will create a thicker frame.

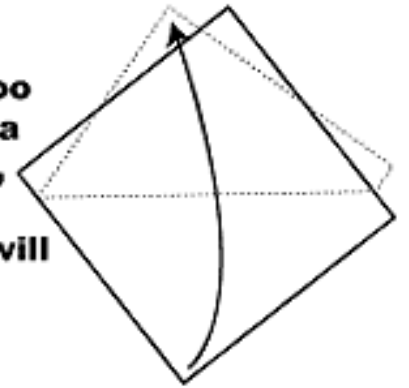

## SUNGLASSES

© Nick Robinson

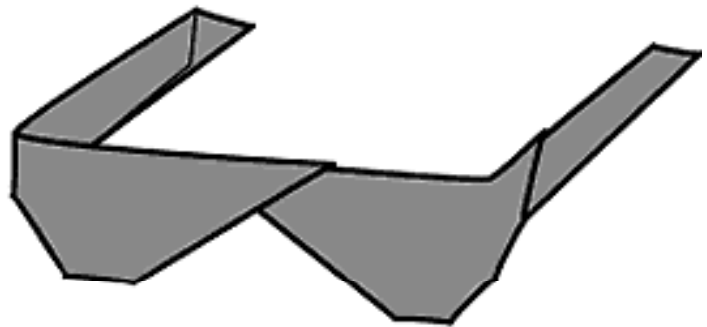



# Simple Models

Please print and use these diagrams freely for personal or educational use. We do ask that you obtain permission before making any commercial use of them. Copyright of the designs belongs to the original creator, although with simple designs, it is highly likely that many people develop the same fold independantly. If you have any suitable creations, drawn to a high standard, please [let us know](#).

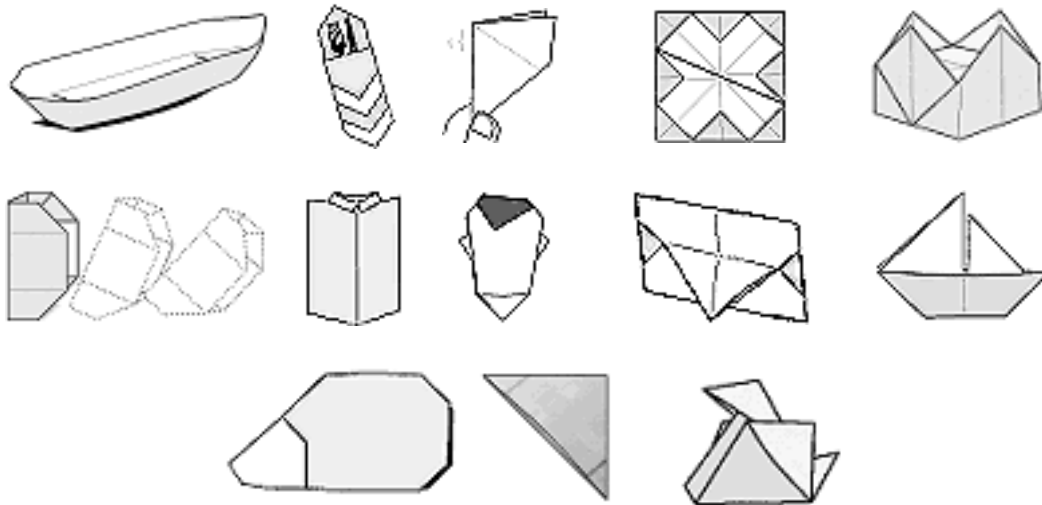

origami  
Diagrams 





# Boat

**Nick Robinson**  
adapted from  
traditional

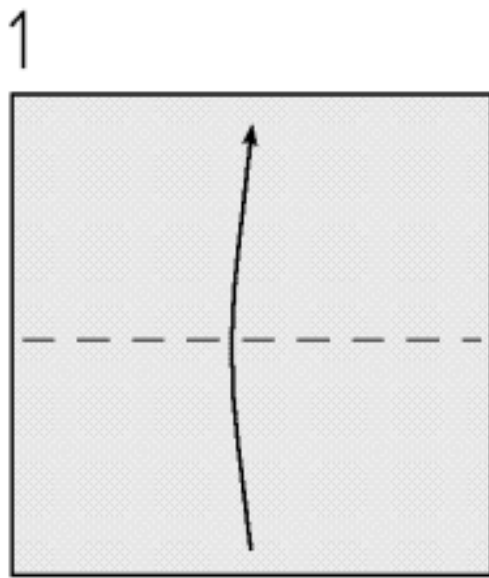

fold the paper in half

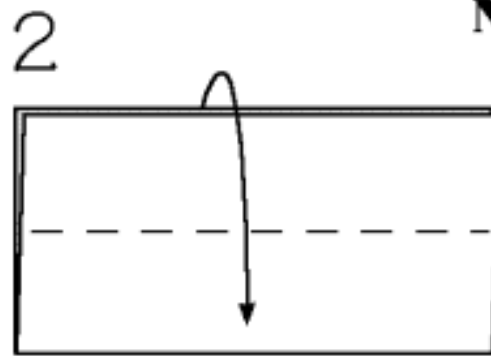

fold both layers

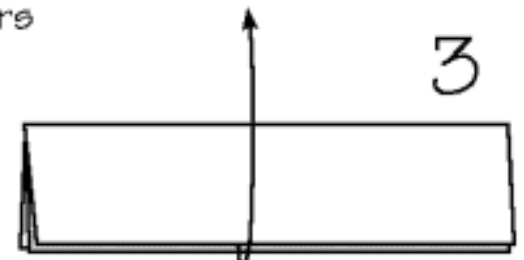

first layer only

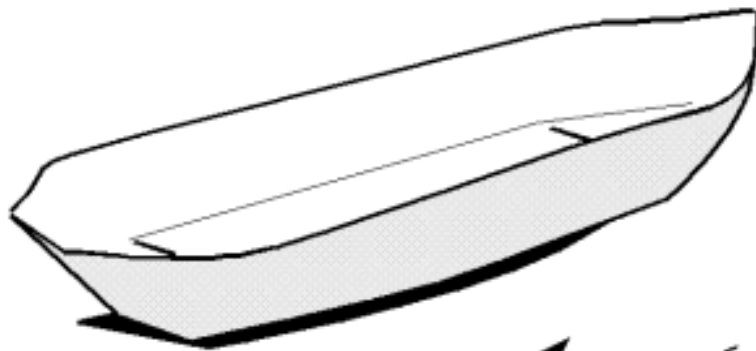

turn the paper over

fold tips under

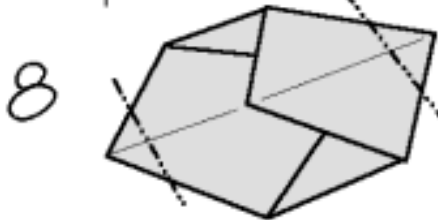

this step determines  
the proportions

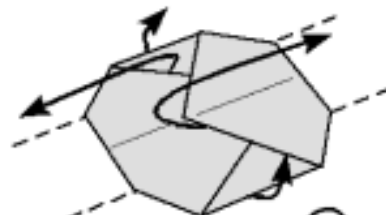

open & shape

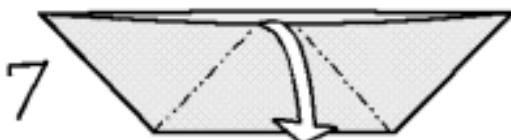

open out  
and flatten

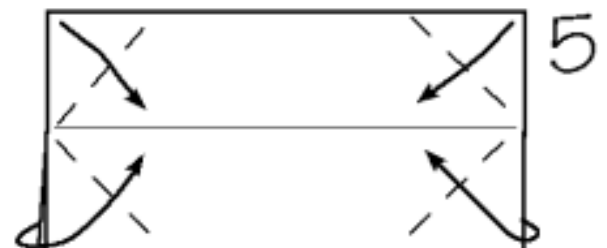

fold all corners in

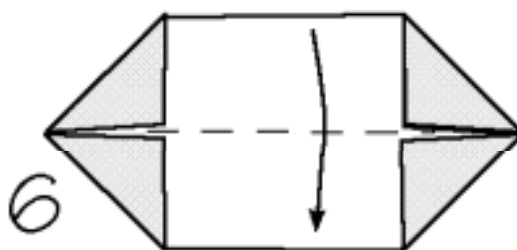

fold in half



This design can also be used as a hat if you make it big enough!

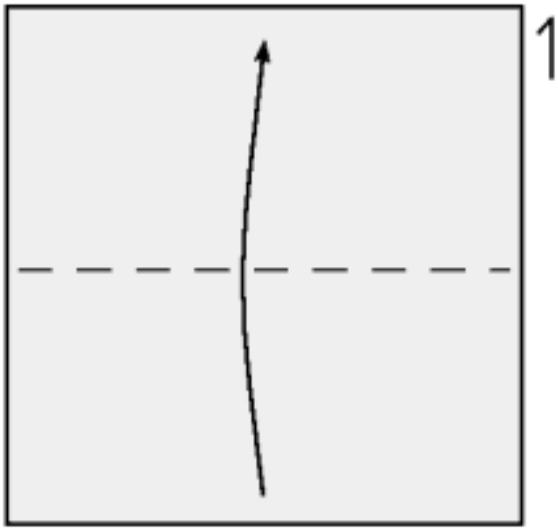

1  
start with a napkin or square

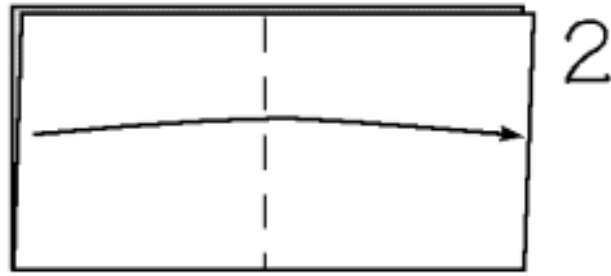

2

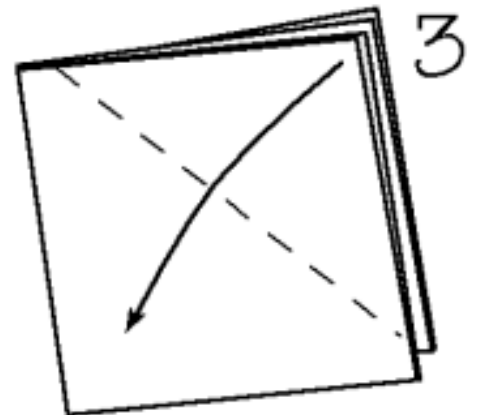

3

one layer only

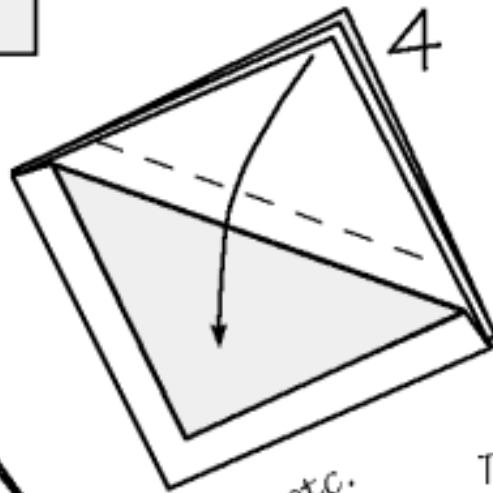

4

etc.

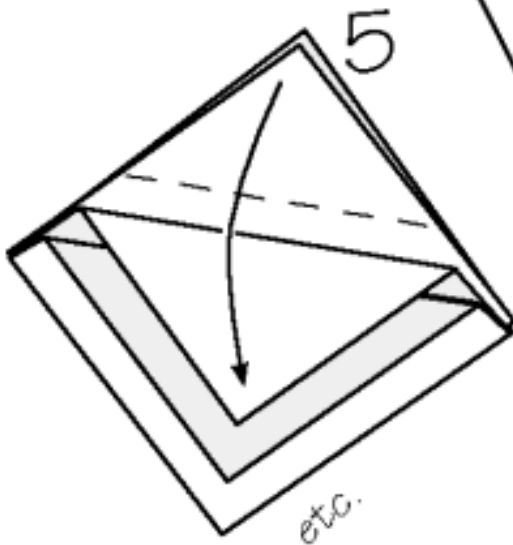

5

etc.

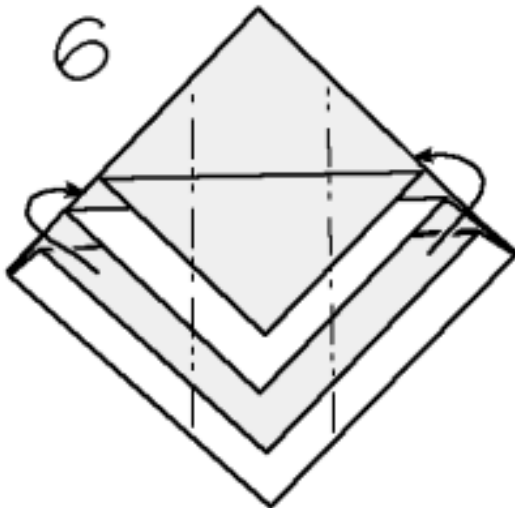

6

Fold the sides behind, they will overlap slightly

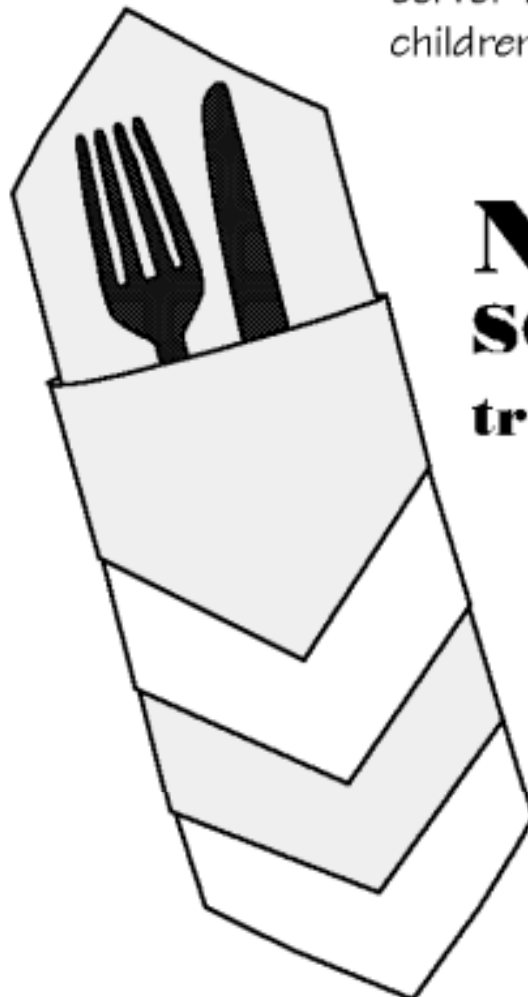

There are many origami folds that work well with paper napkins. This napkin server is great for children's parties!

# Napkin server

traditional





# Banger

traditional

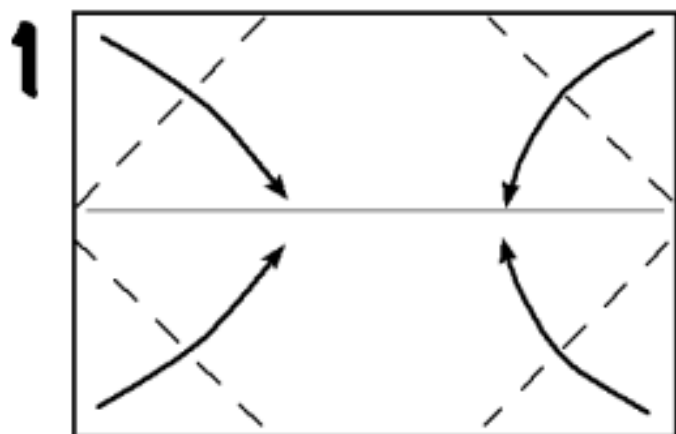

fold the corners to the centre crease

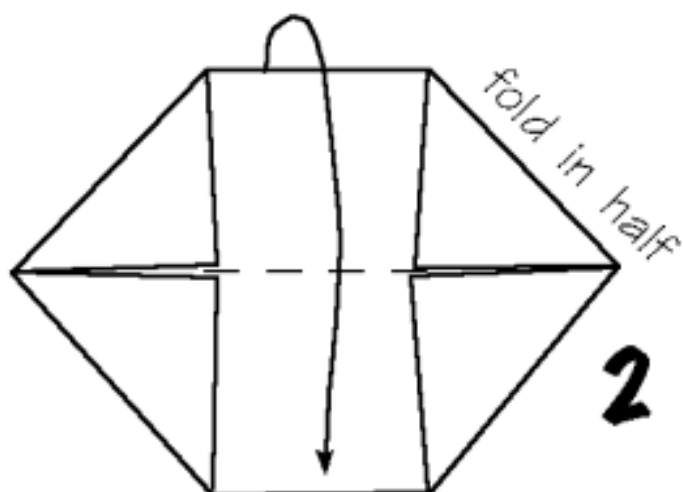

# BANG!

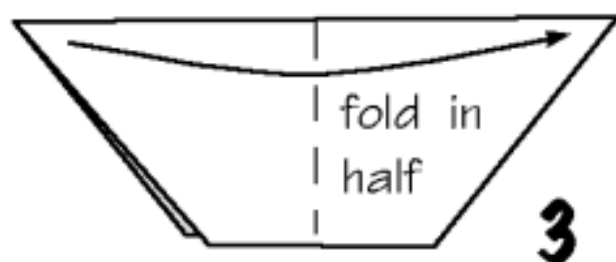
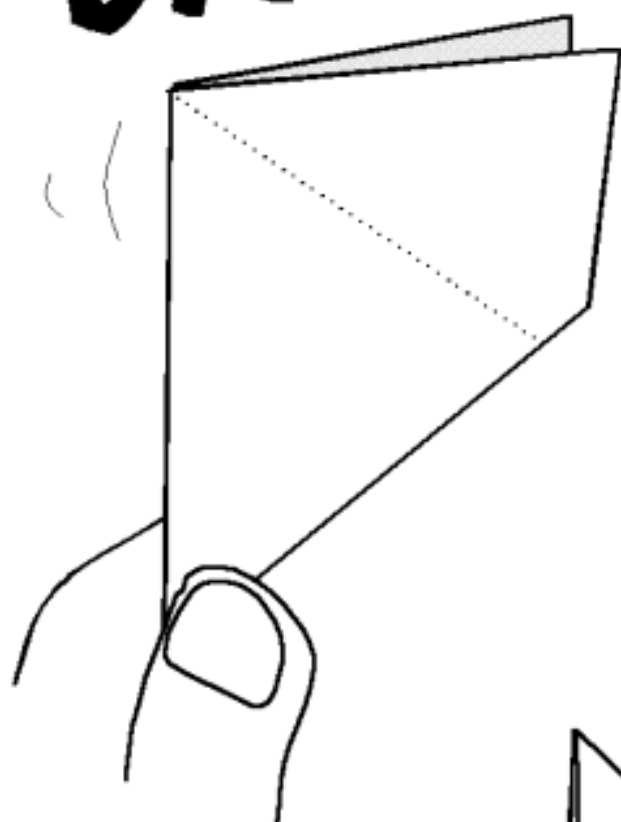

swing both flaps down

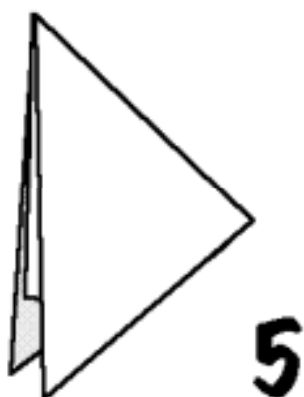
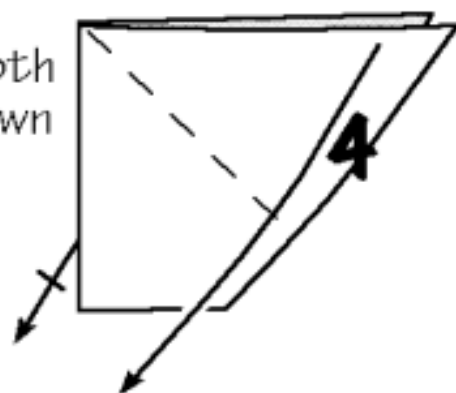

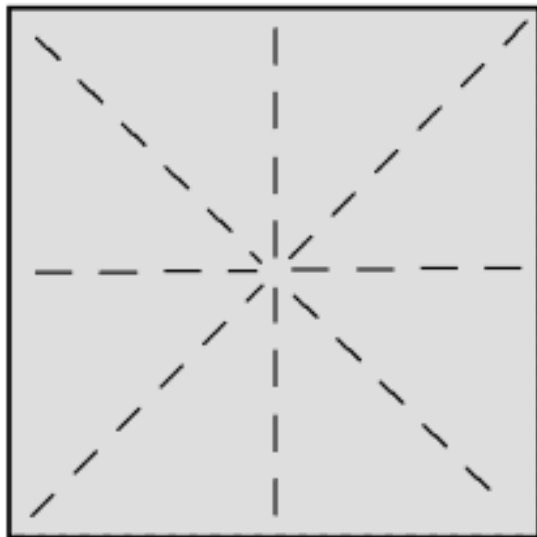

# Cross

© Nick Robinson

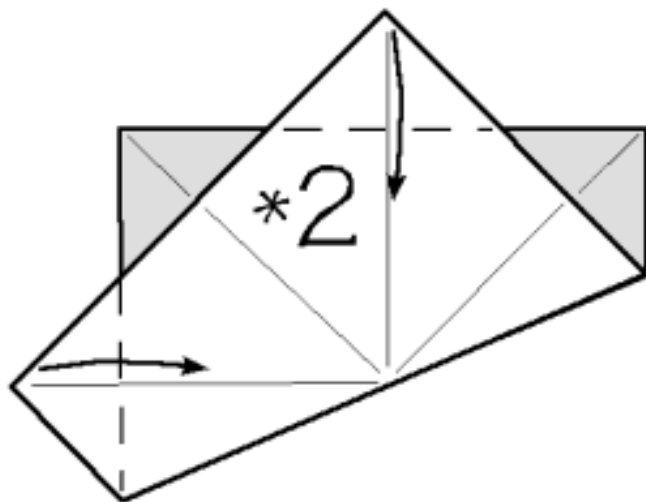
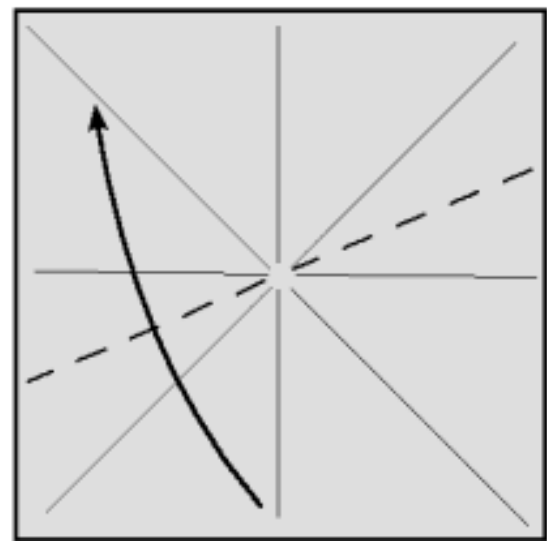

The hidden geometries of origami are surely the key to its fascination. The appeal of this simple design (for me) is the surprise of producing a unlikely cross from such familiar creases.

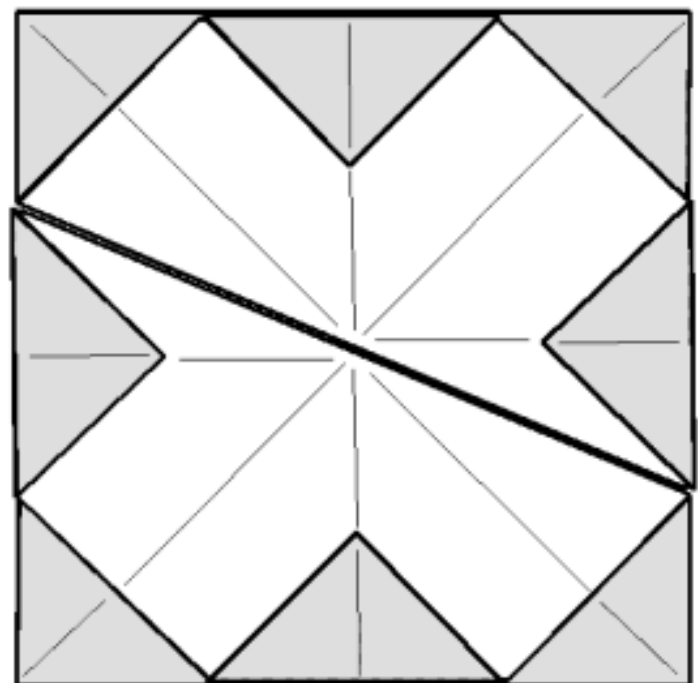

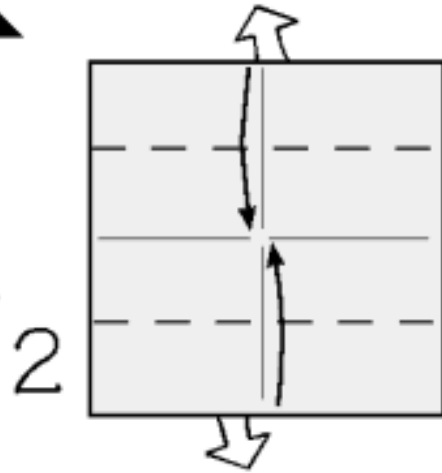
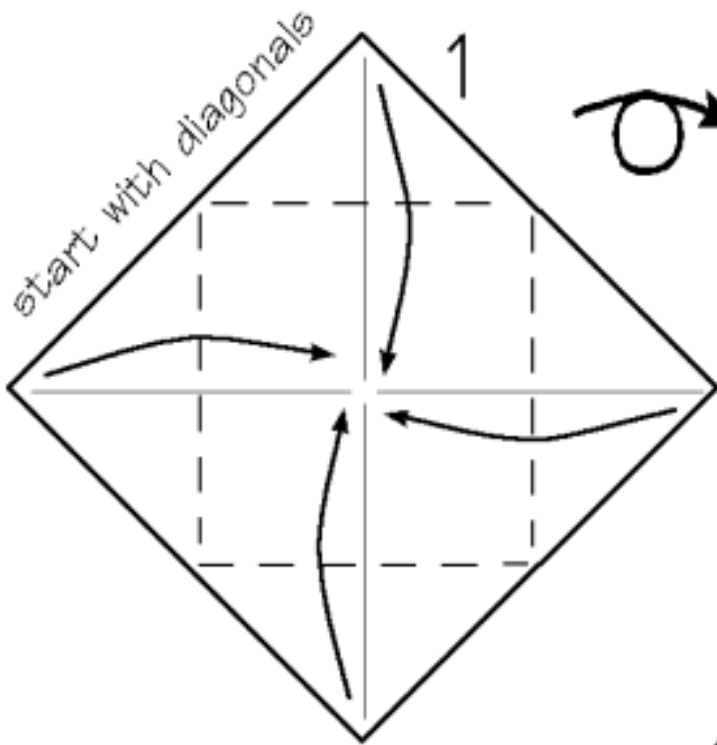

The corners pop out from underneath

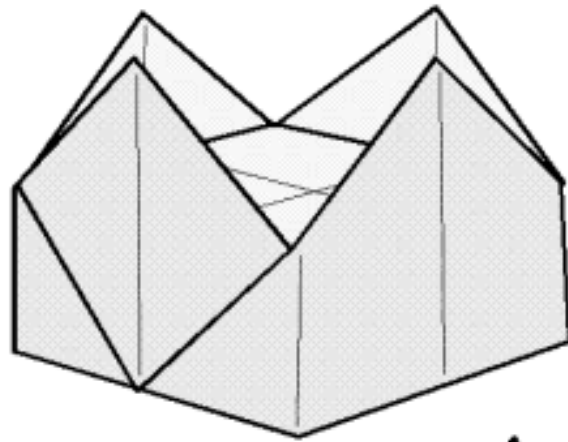
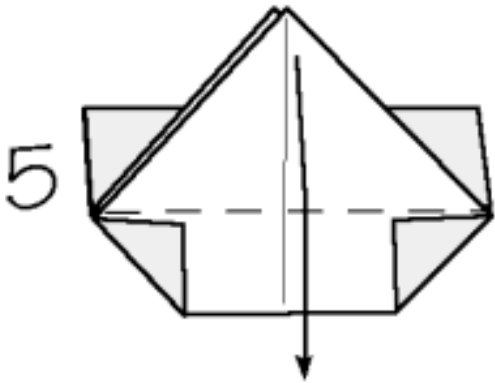
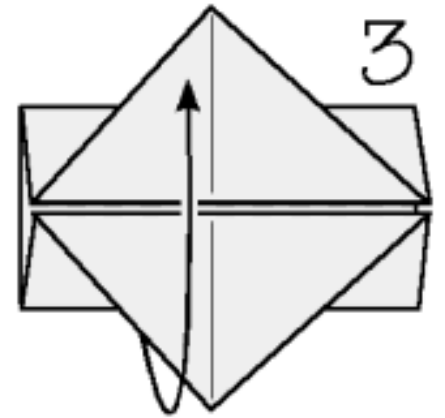
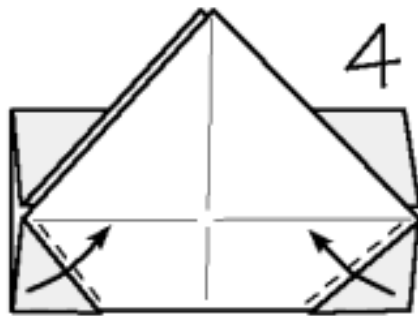

© BOS2000

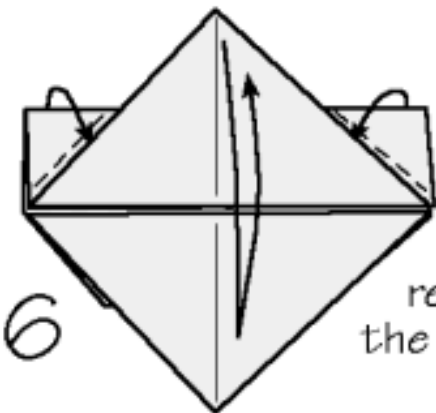

repeat on the other side

## Crown traditional

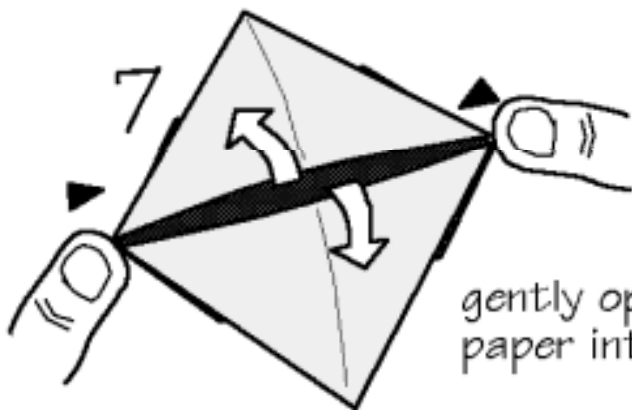

gently open the paper into 3D

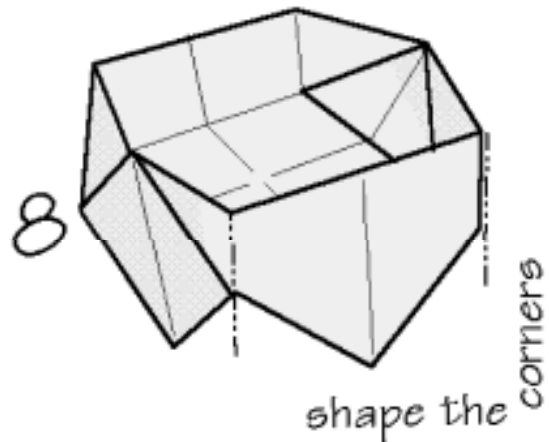

shape the corners



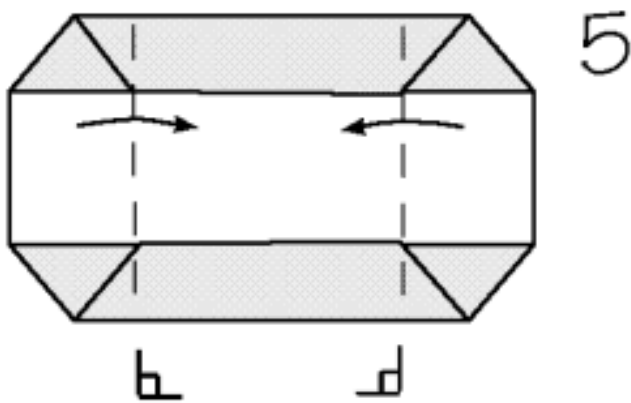
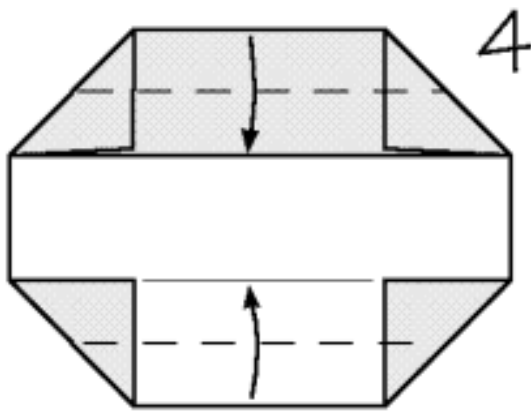
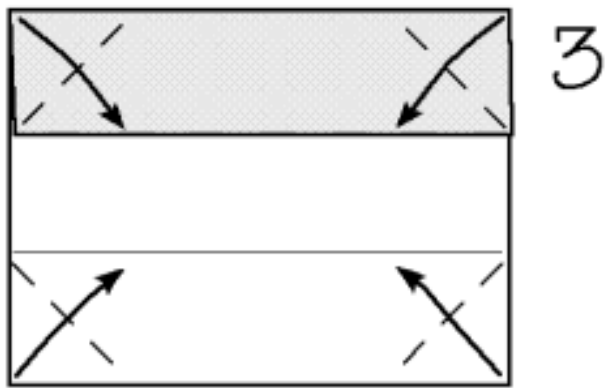
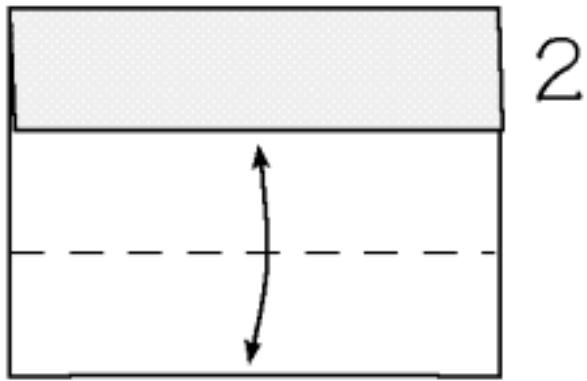

fold both sides in at right angles

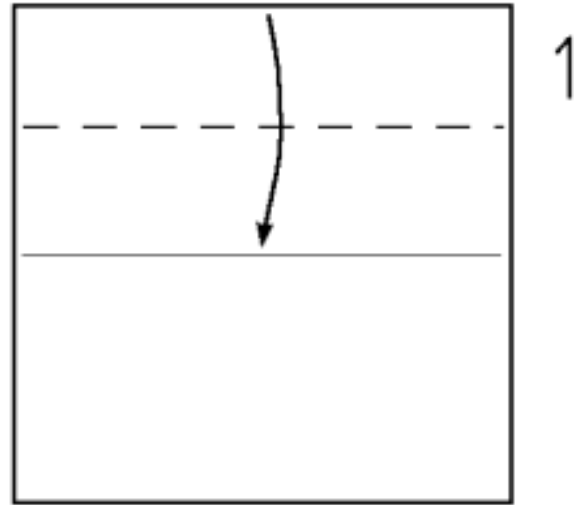

# Tumbling Man

Seiro Takekawa

Place the fold with the thicker edge on top, tip it over with your finger & it will turn a somersault. Let your friends try it with the thinner end upwards - it won't work!



©BOS2000

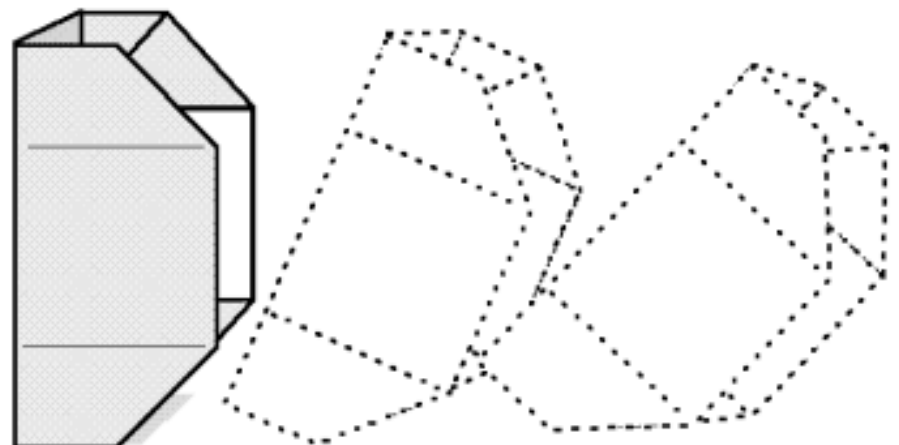



# Shirt

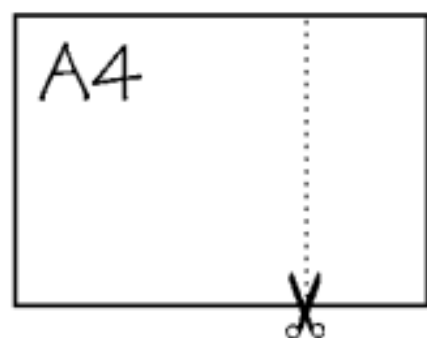

Cut a square from an A4 rectangle and use the bit left!

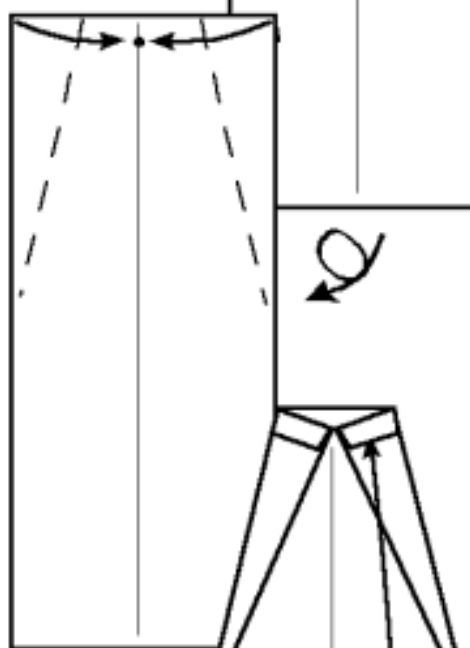
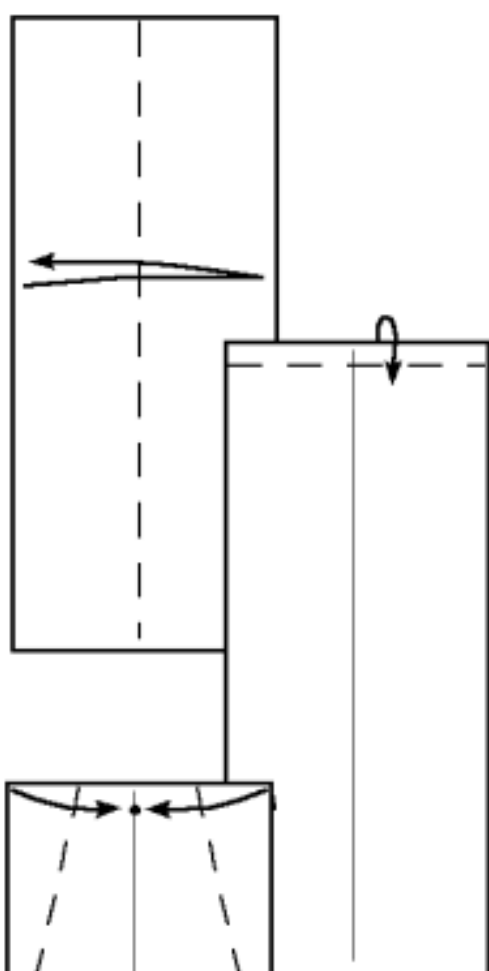

tuck under

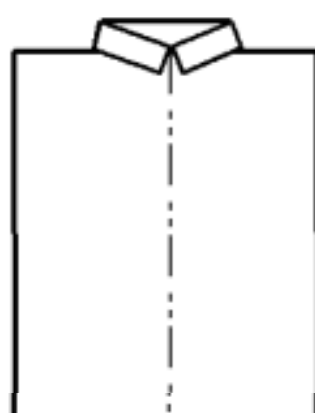
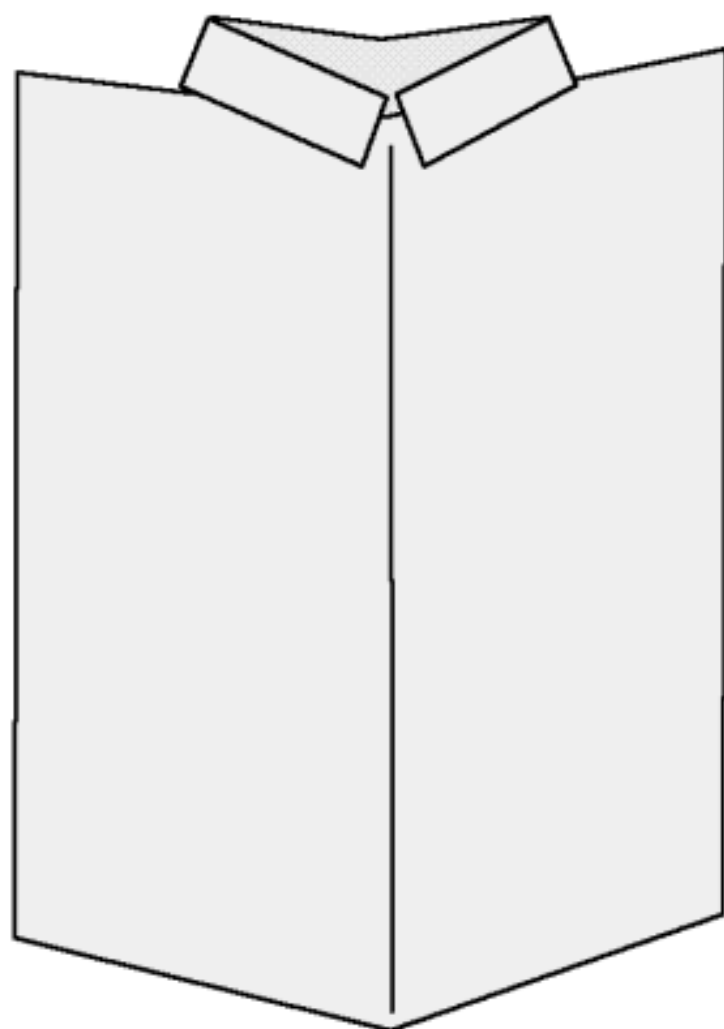
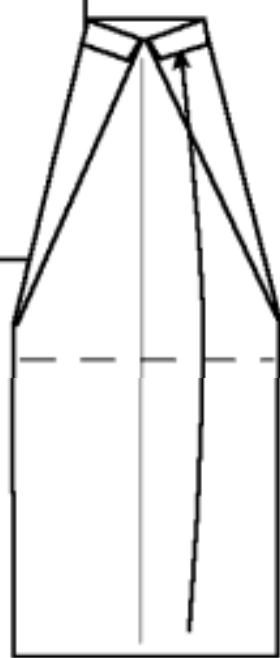

Gently reinforce the centre crease so it will stand

This simple shirt makes a great party invitation!





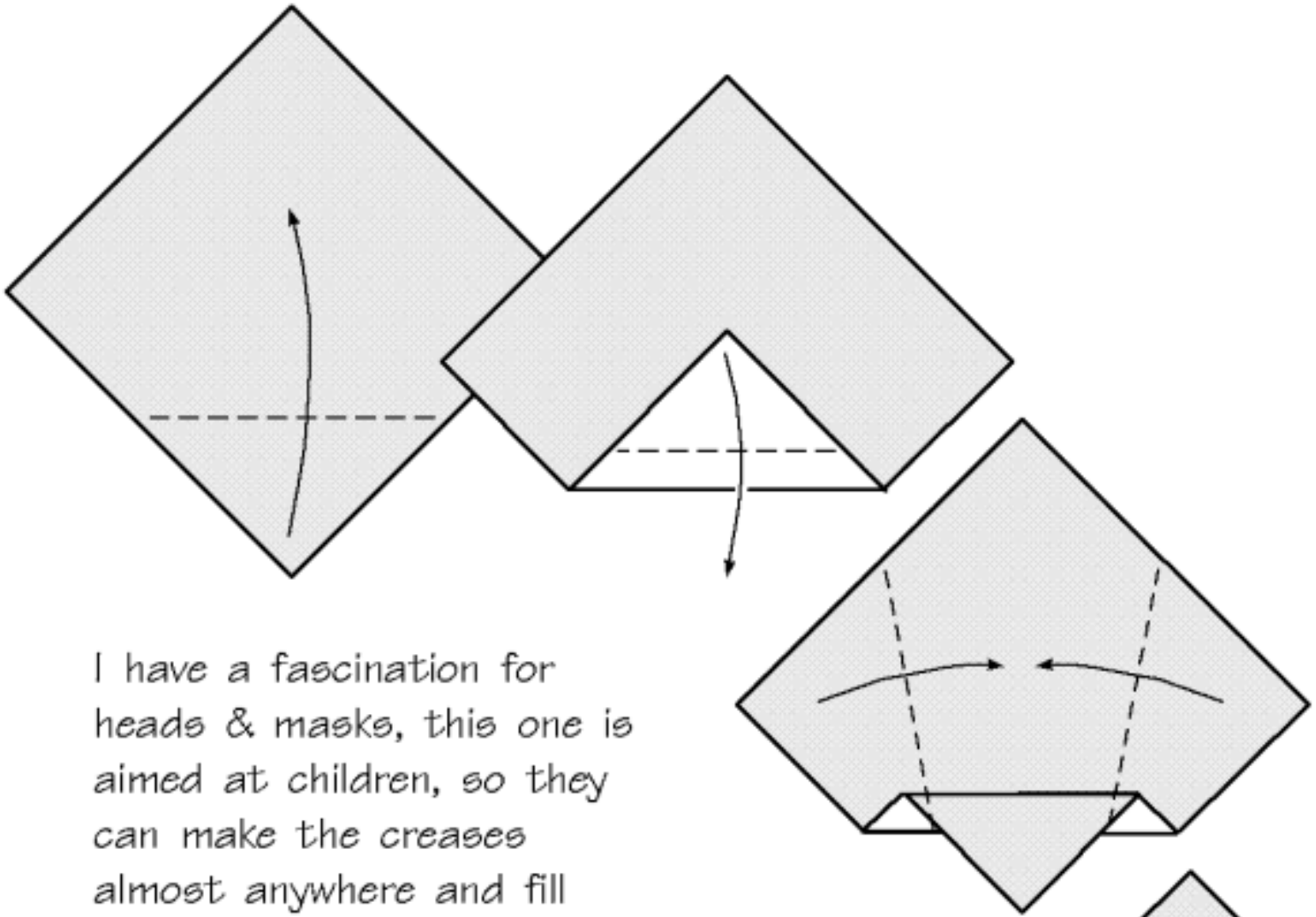

I have a fascination for heads & masks, this one is aimed at children, so they can make the creases almost anywhere and fill their own features in.



# Face

© Nick Robinson

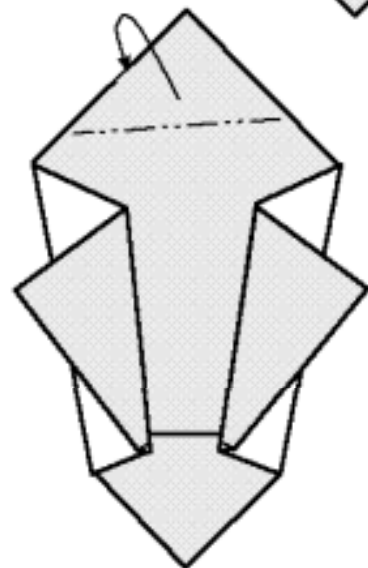
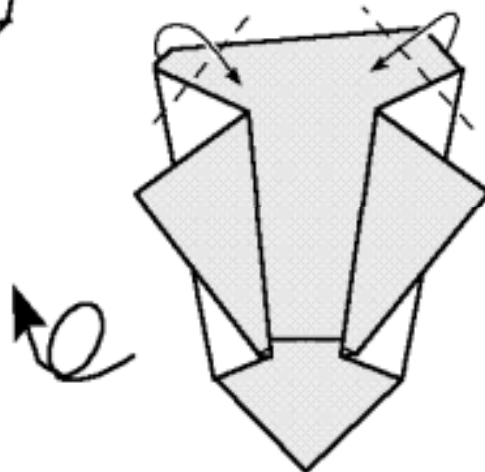
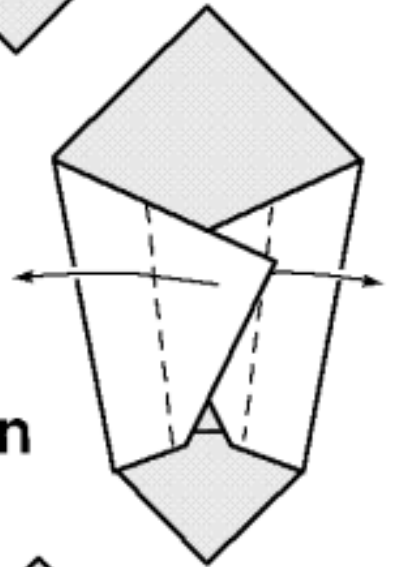

Start with A4 or similar

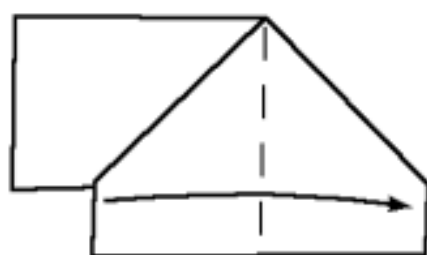
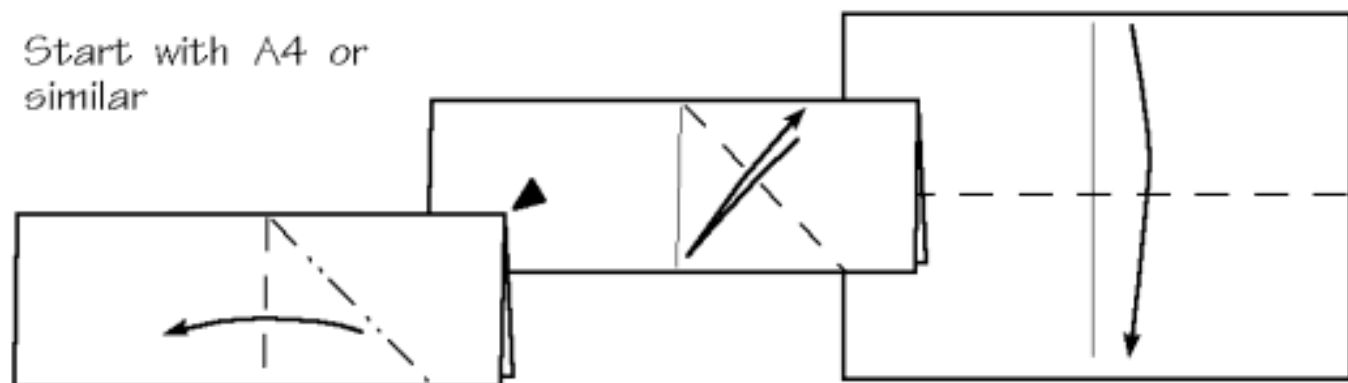

repeat on other side

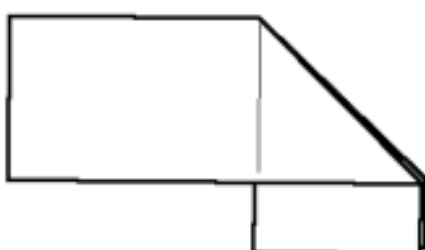

swing to the left, also underneath

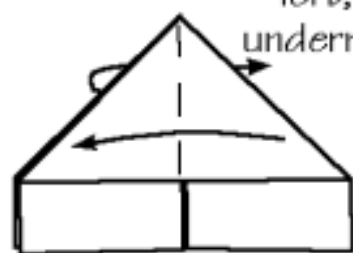

# Picture Frame

## Larry Hart

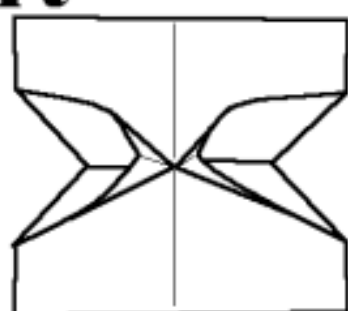
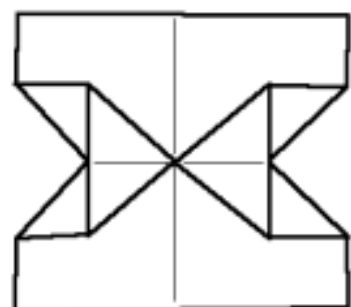

squash gently

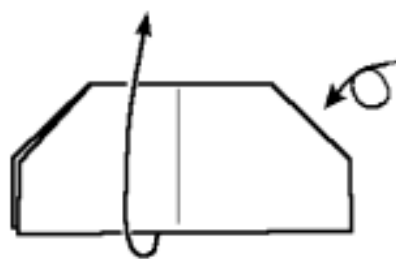

open first layer

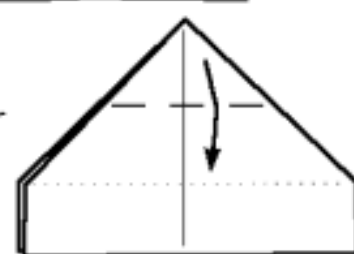

©BOS2000

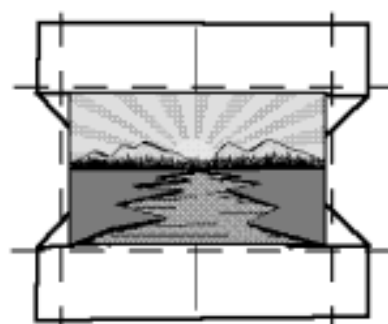

crease around & remove photo

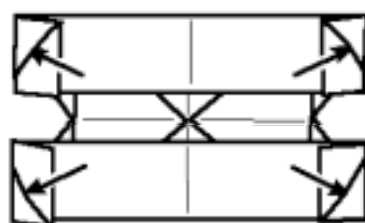
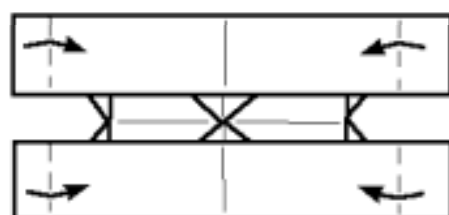
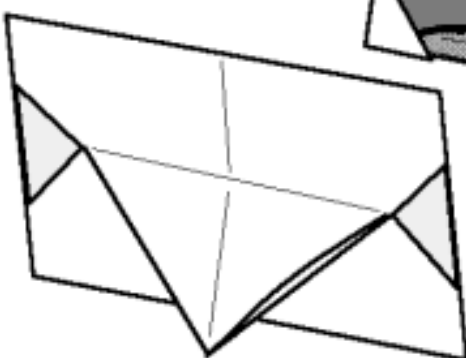
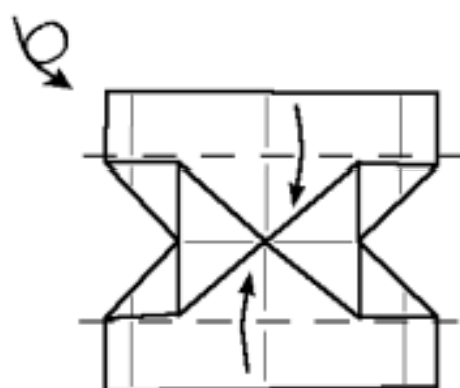
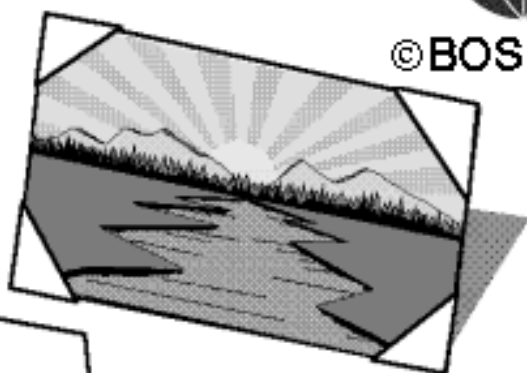

reinsert photo

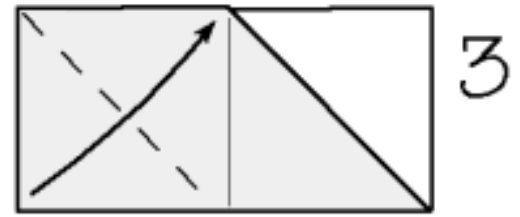
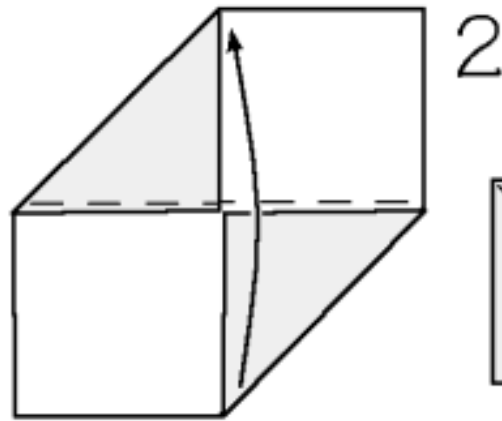
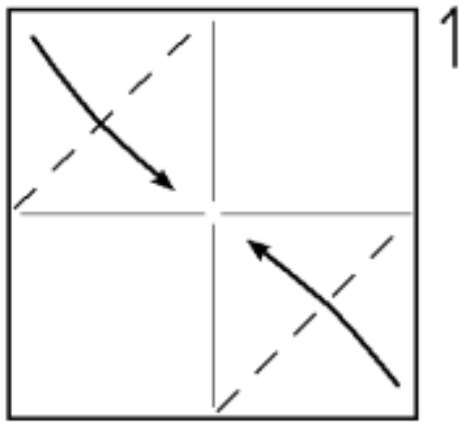

# Sailboat

traditional

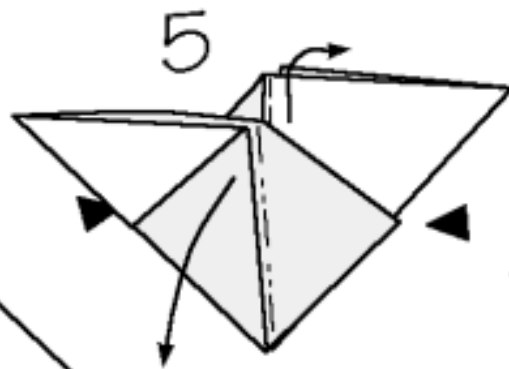
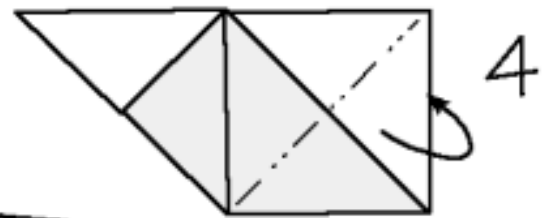

Open the central pocket and press the sides together

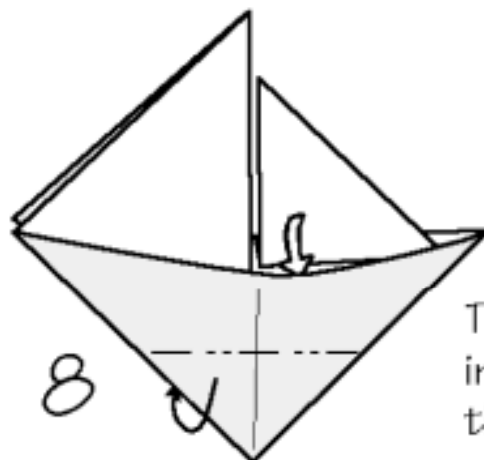
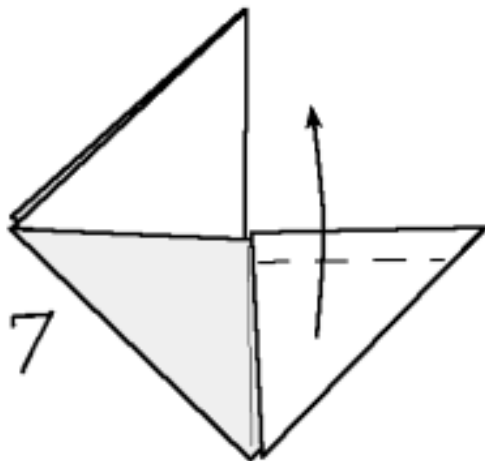
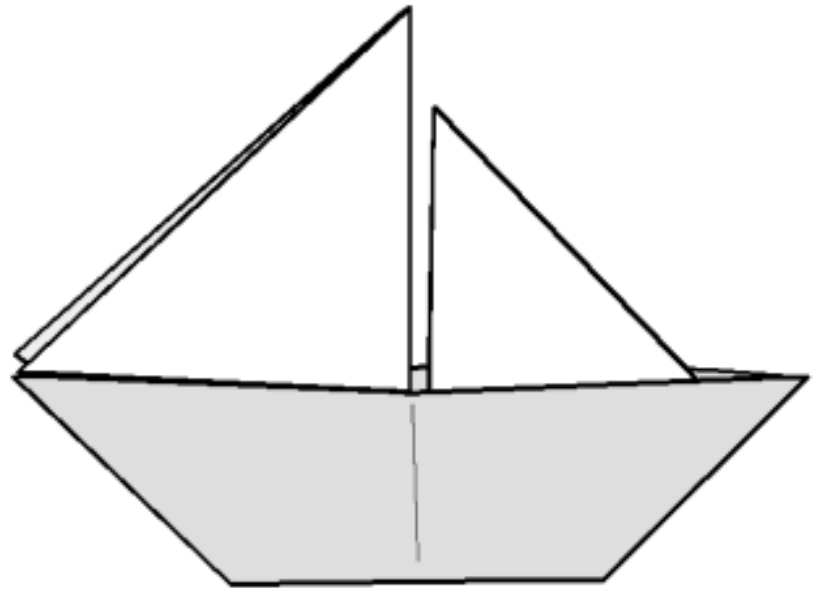
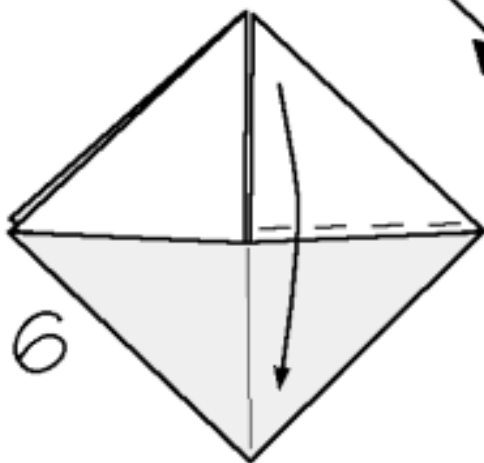

This design is the symbol of Origami USA



©BOS2000

Tuck the small sail inside the boat. Fold the base behind to make a stand

# Hedgehog

Tony O'Hare

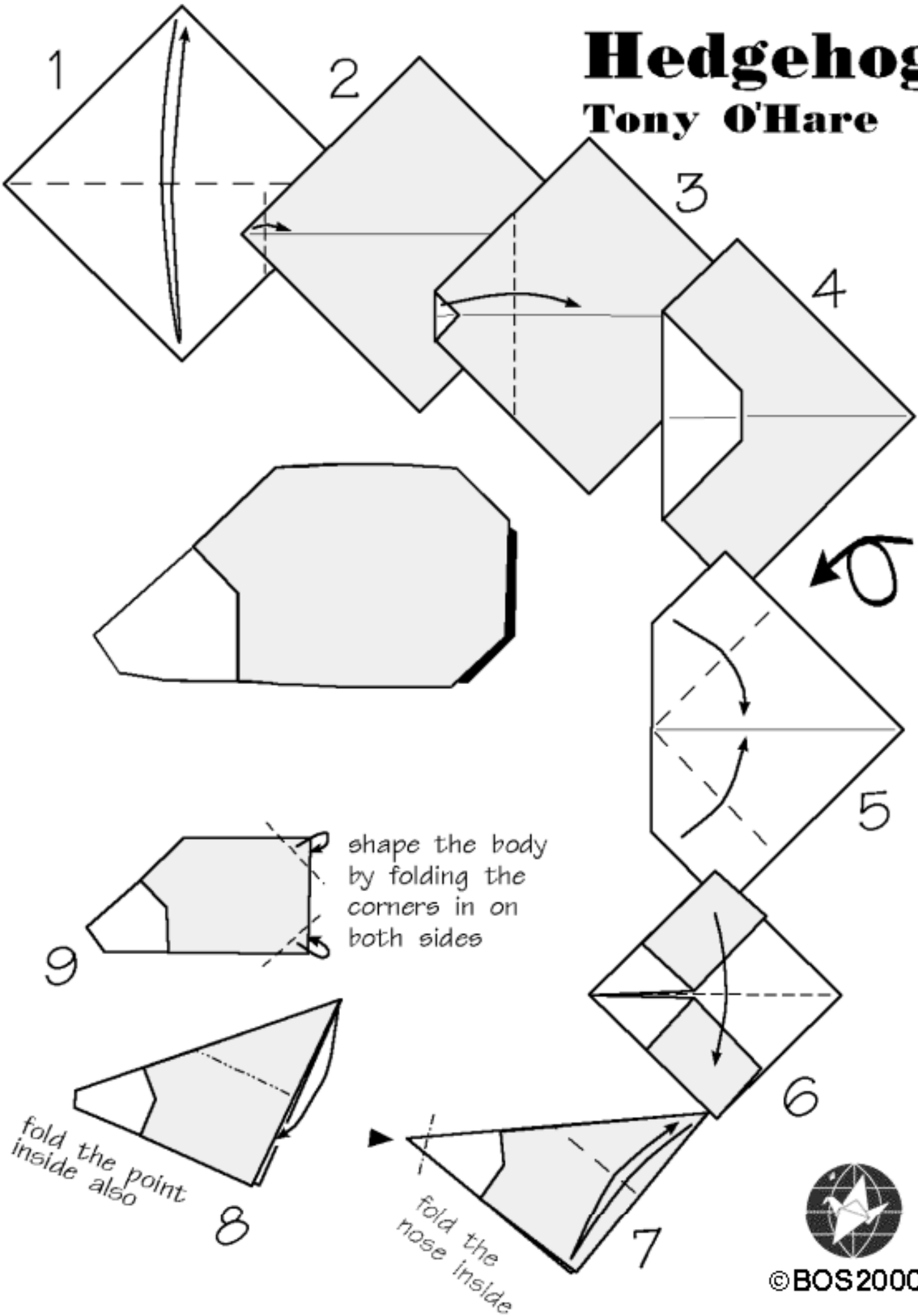

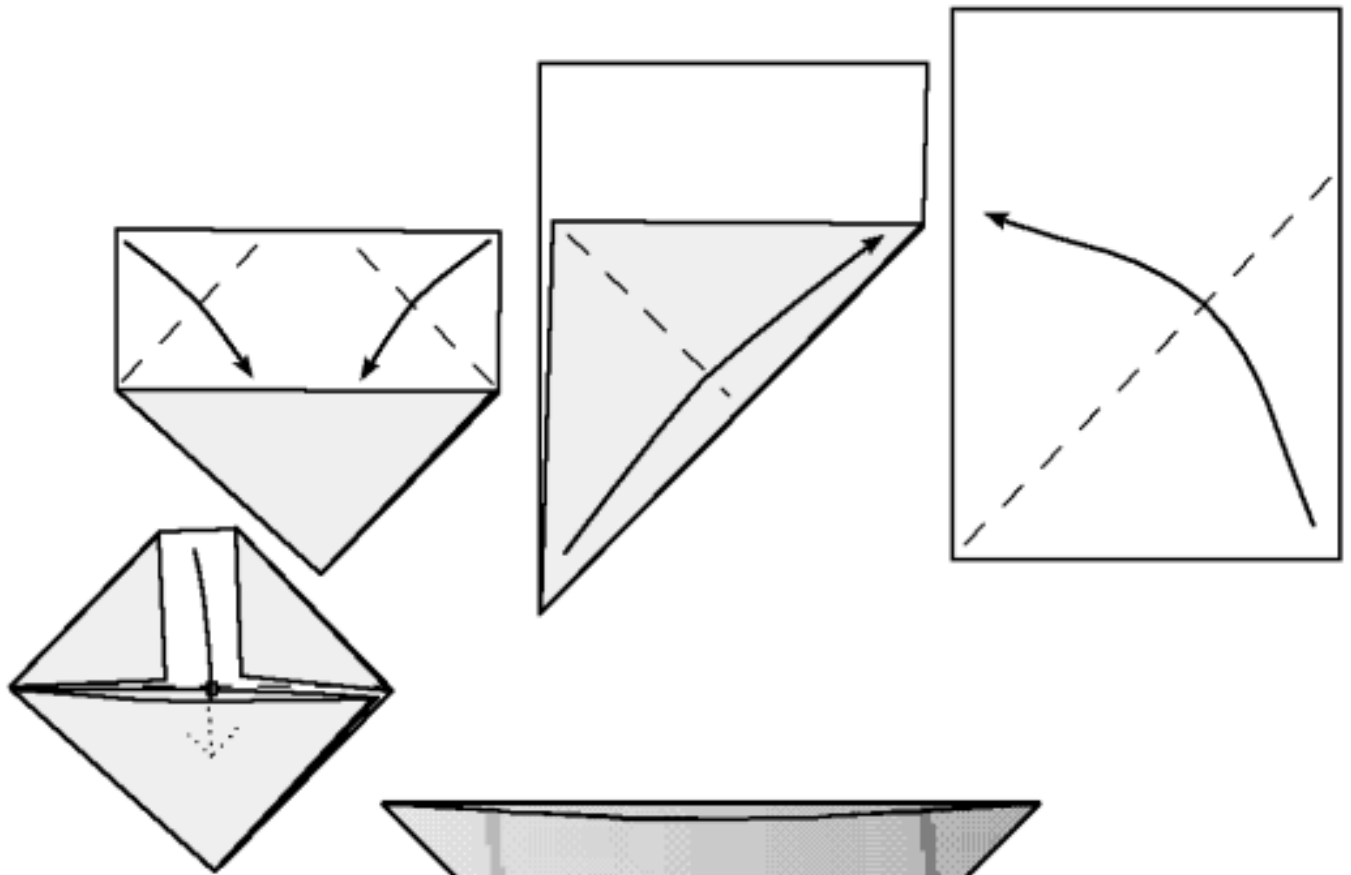

# Book marks

© Nick Robinson

I enjoy creating simple yet practical designs. These bookmarks are not unique, but I (re)discovered them, which for me is the main point. Made big enough, they can be worn as hats!

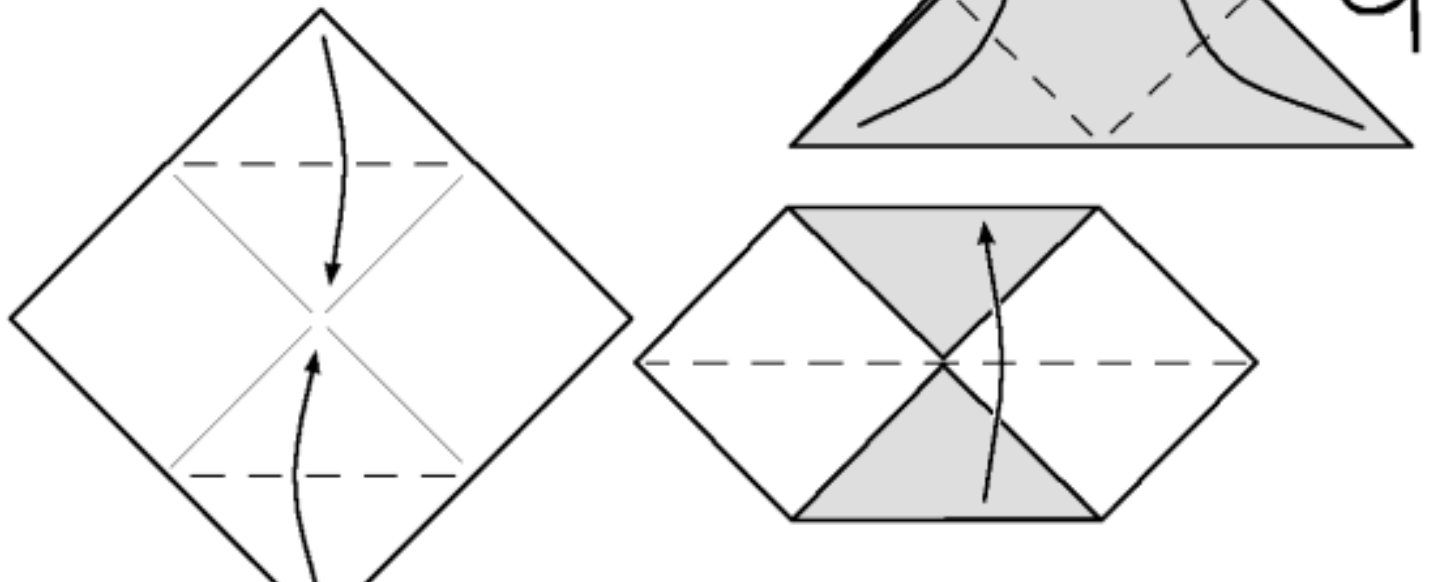



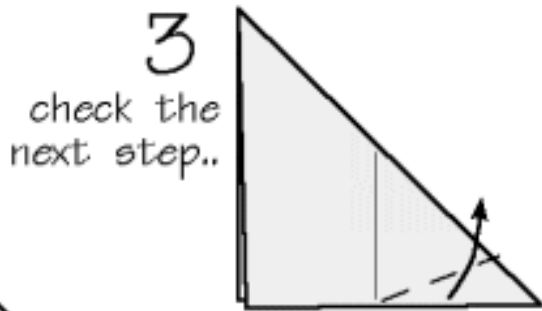
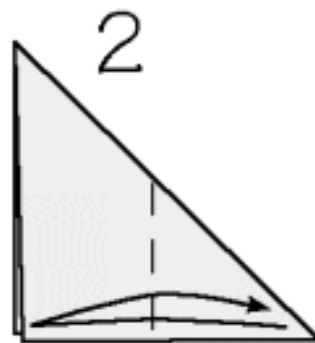
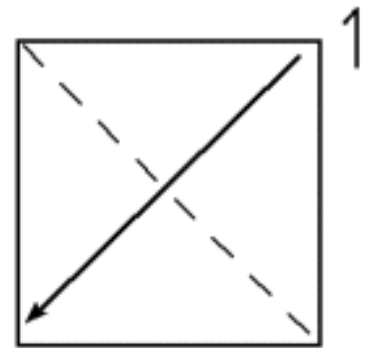

check the next step..

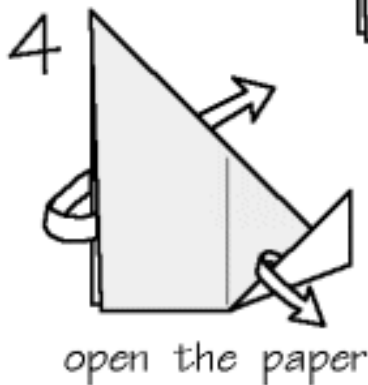

open the paper

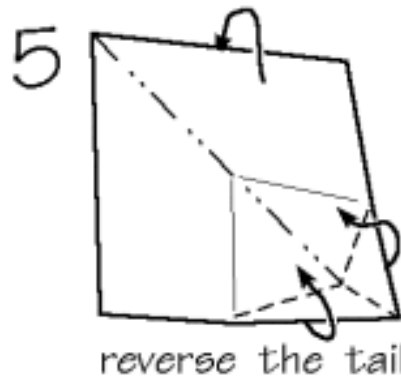

reverse the tail

this design is a surprise until the very last step!

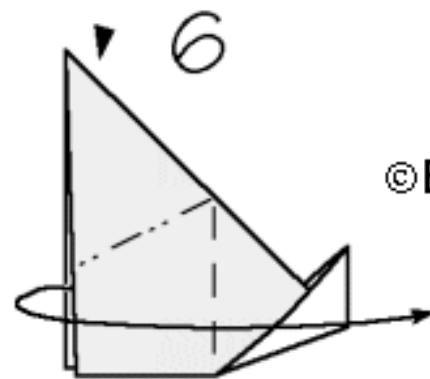

swing open & flatten the centre



©BOS2000

# Duck

Edwin Corrie

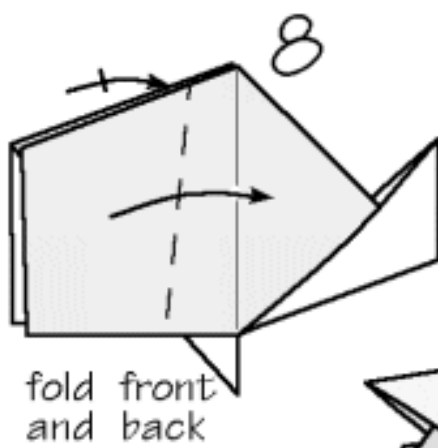
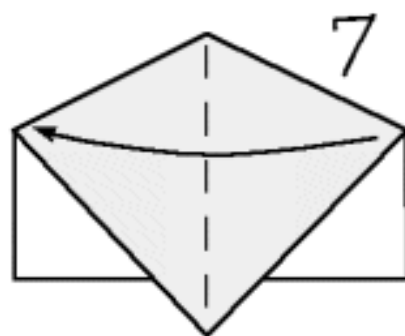

fold front and back

